

FTS, FTT

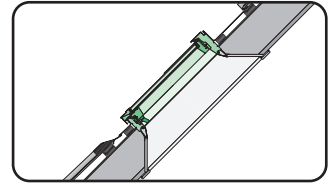

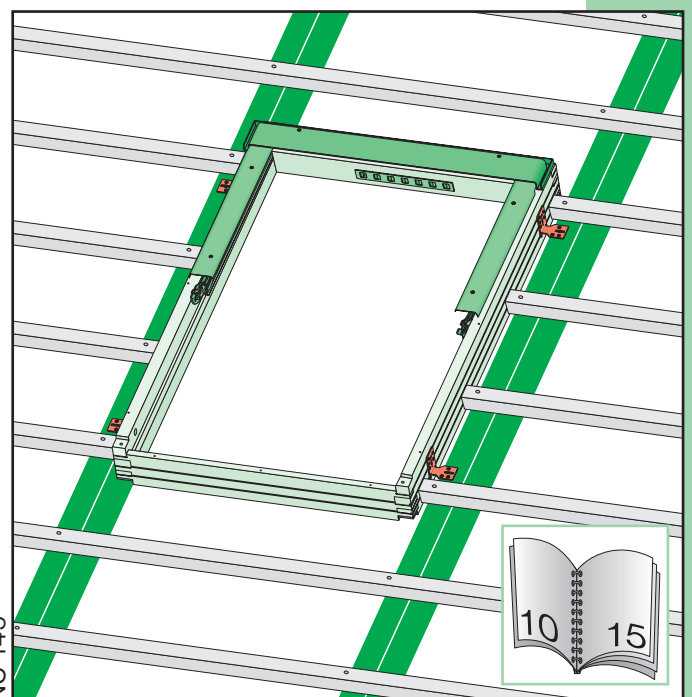

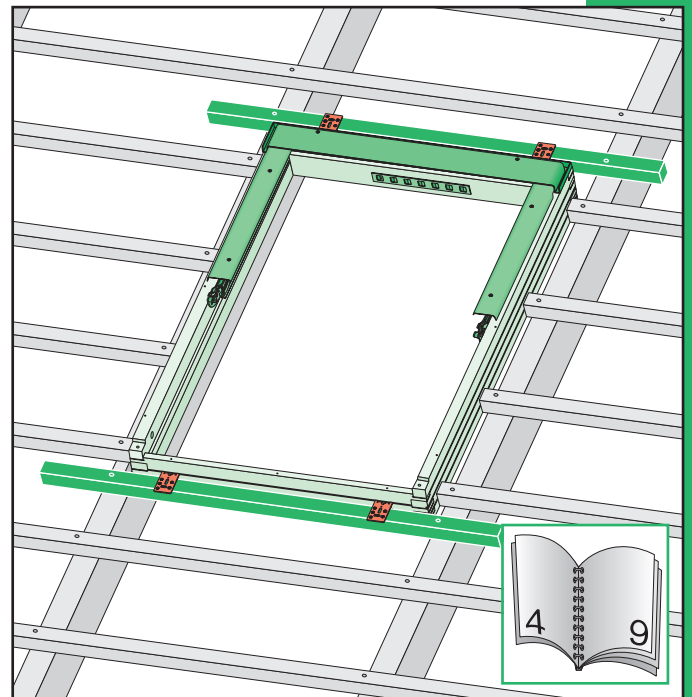

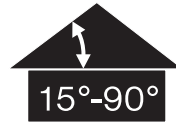
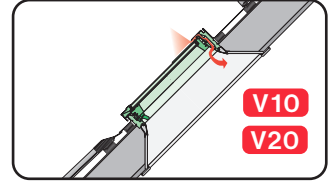



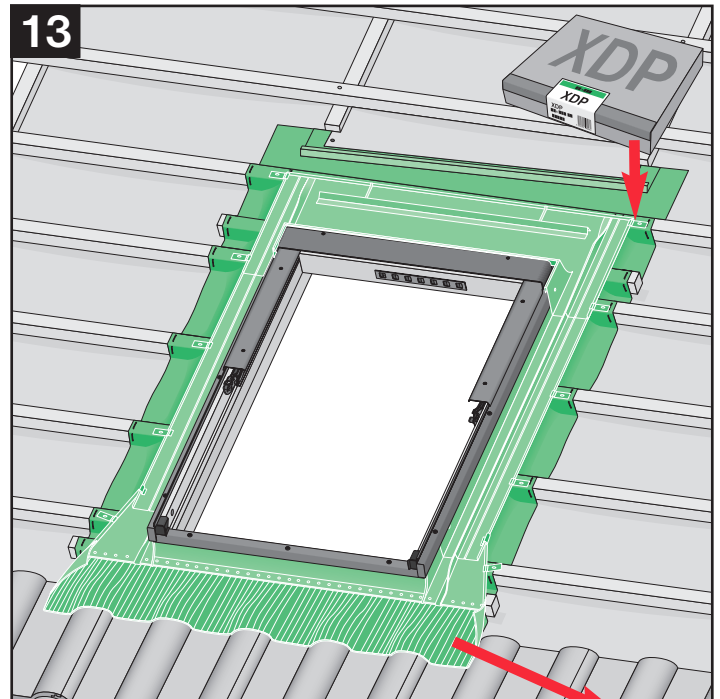
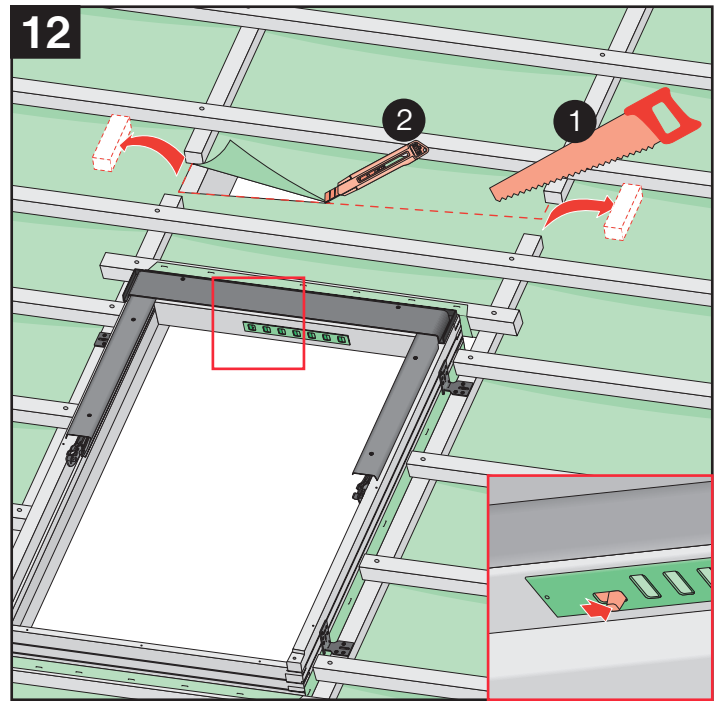
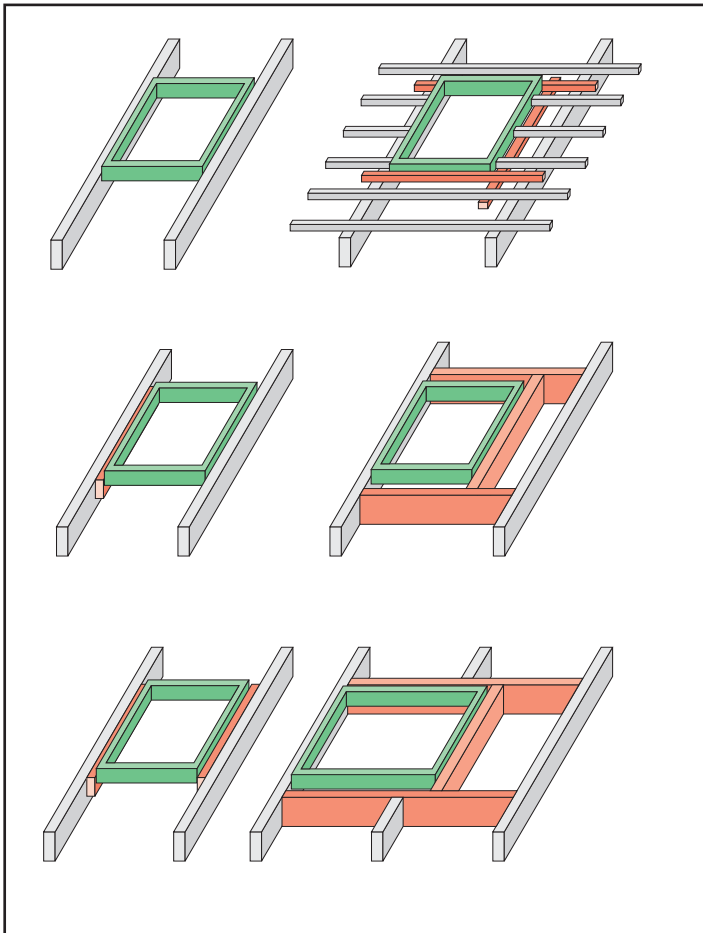
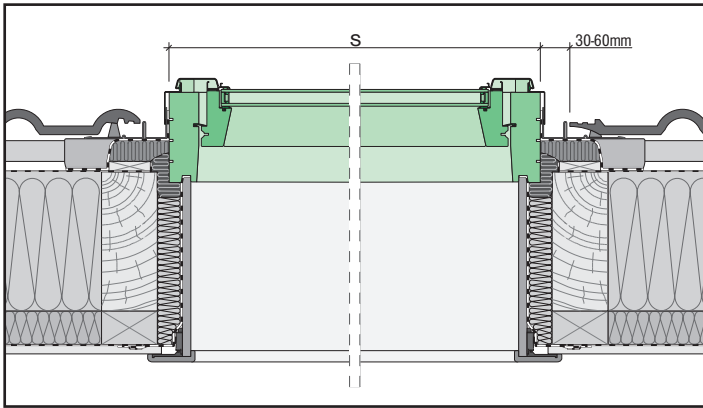
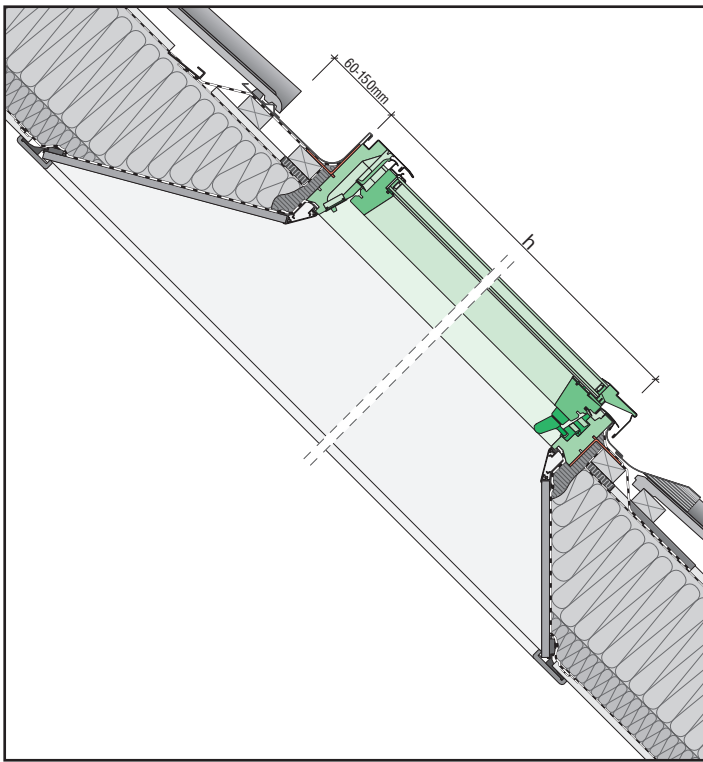



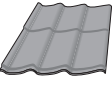
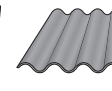

FTS-V

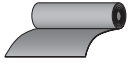

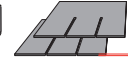
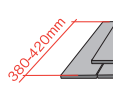
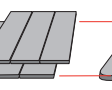
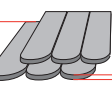
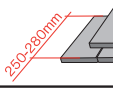
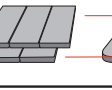
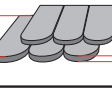
NC 145

- | | | | |
|-----------|--|------------|--|
| CZ | Vyrobcе a Prodávce nenеsе žádnou odpovědnost za nedodržení příslušných předpisů zákona, stavebních předpisů a bezpečnostních požadavků přes uživatele výrobku, architekta, montéra nebo majitele objektu. | NL | De fabrikant en verkoper zijn niet aansprakelijk voor gevolgen bij het niet opvolgen van toepasselijke wetten, bouwbesluiten en veiligheidsvoorschriften door de gebruiker van het product, de architect, de installateur of de eigenaar van het gebouw. |
| D | Hersteller und Verkäufer übernehmen keine Haftung für Nichtbeachtung entsprechender Rechts- und Bauvorschriften sowie Sicherheitsanforderungen seitens Produktbenutzers, Architekten, Monteurs oder Gebäudebesitzers. | PL | Producent i Sprzedawca nie ponosi żadnej odpowiedzialności za niezapewneżenie stosownych przepisów prawa, przepisów budowlanych i wymagań bezpieczeństwa przez użytkownika produktu, architekta, montażystę lub właściciela budynku. |
| E | El fabricante y el vendedor no tienen ninguna responsabilidad por el incumplimiento de la ley vigente, normas de construcción y exigencias de seguridad por parte del usuario del producto, arquitecto, instalador o el propietario del edificio. | PT | O fabricante e o vendedor não tem nenhuma responsabilidade pelo o não cumprimento da lei, códigos de construção e as exigências de segurança por parte do usuário do produto, arquiteto, instalador ou proprietário do edifício. |
| FR | Le fabricant et le revendeur ne prend aucune responsabilité de ne pas respecter les lois applicables, les règlements sur les bâtiments et les exigences de sécurité par l'utilisateur du produit, l'architecte, l'installateur ou le propriétaire du bâtiment. | RO | Nici producătorul, nici distribuitorul nu își vor asuma niciun fel de răspundere pentru nerespectarea legilor în vigoare, a legilor din domeniul construcțiilor sau a măsurilor de siguranță impuse utilizatorilor produsului, arhitecților, montajorilor sau proprietarilor clădirii. |
| GB | Manufacturer and seller shall bear no liability for failure to comply with the applicable laws, building codes and safety requirements by the user of the product, architect, fitter or owner of the building. | RUS | В случае несоблюдения архитектором, монтажником или владельцем здания строительных правил и норм безопасности ответственность с производителя и продавца снимается. |
| H | A gyártó és a forgalmazó nem vállal semmiféle felelősséget a vonatkozó törvényi, építési és biztonsági előírások terhelésénél, építész, beszállómester vagy épületgazdának által be nem tartásáért. | SK | Výrobca a predávca nenesu žiadnu zodpovednosť za nedodržanie príslušných ustanovení zákona, stavebných predpisov a bezpečnostných požiadaviek užívateľom výrobku, architektom, montérom alebo majiteľom objektu. |
| I | Il Produttore e il Rivenditore non potranno essere ritenuti responsabili per il mancato rispetto, da parte dell'utente del prodotto, del progettista, dell'installatore o del proprietario dell'edificio, delle leggi vigenti, nonché dei regolamenti edilizi e di quelli relativi alla sicurezza. | | |

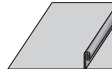

			max 90mm	EHN EHV
			max 45mm	EZN EZV EZJ
			max 5mm	ESN ESV ESJ
			12-16mm	EGV
			max 18mm	EPV
			max 5mm (V,J) max 15mm (N)	ELN ELV ELJ
				EEN EEV EEJ

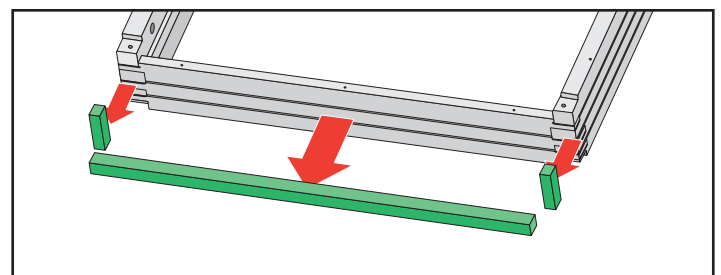
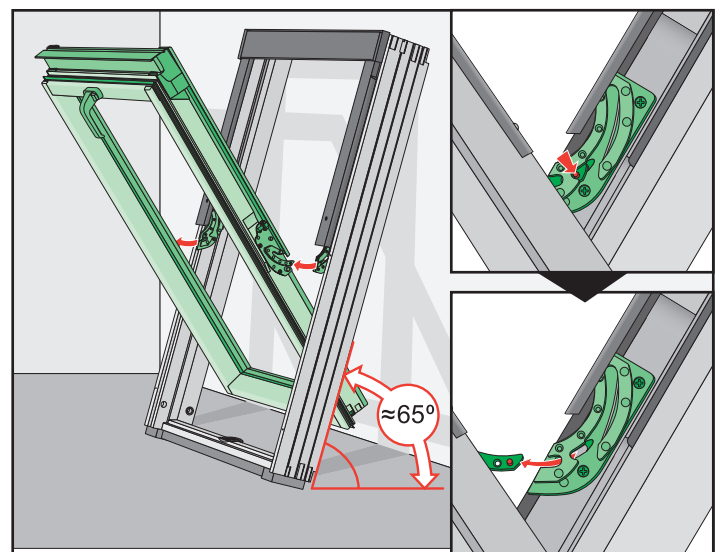
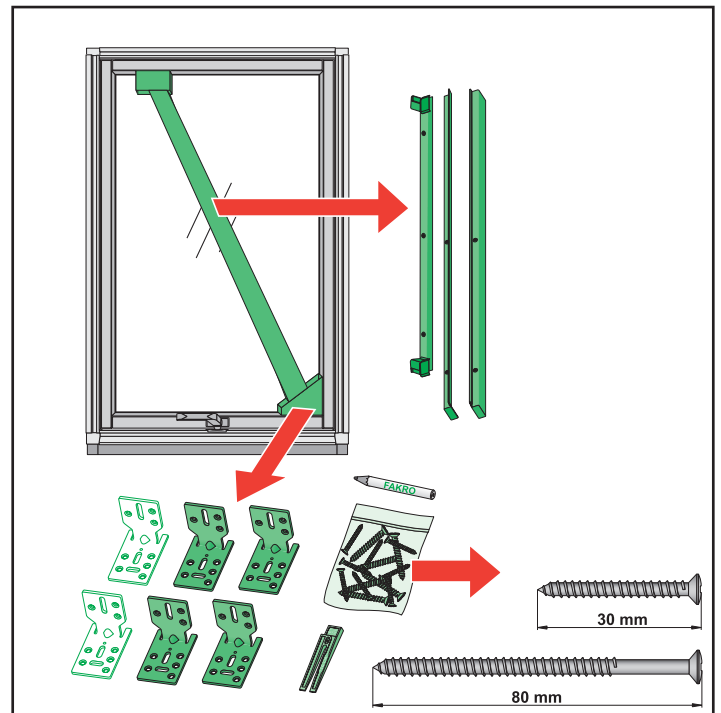
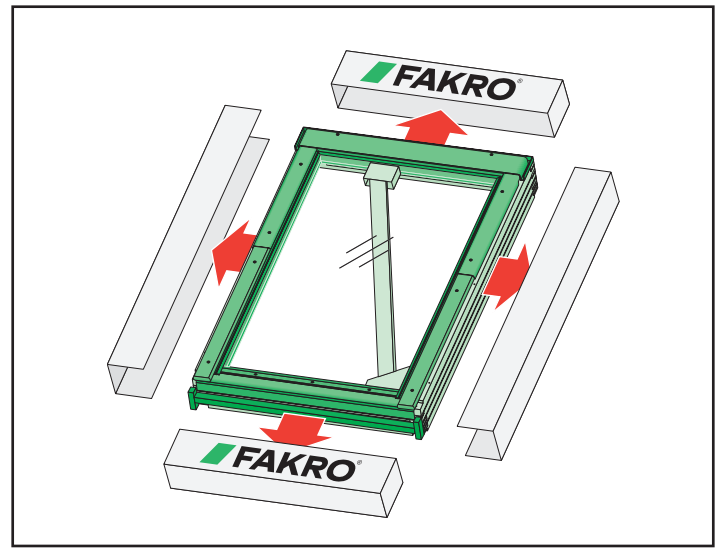
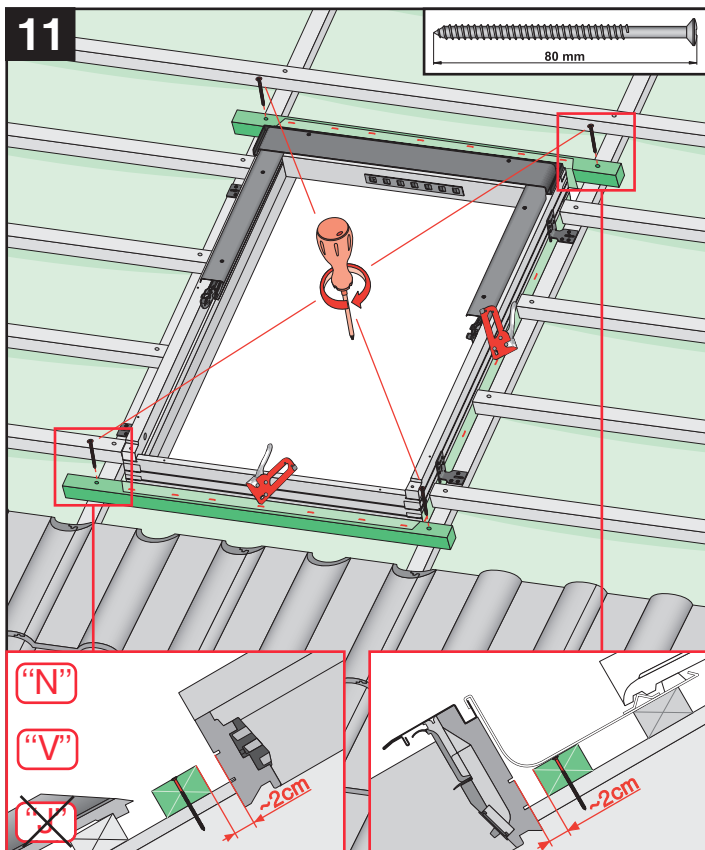
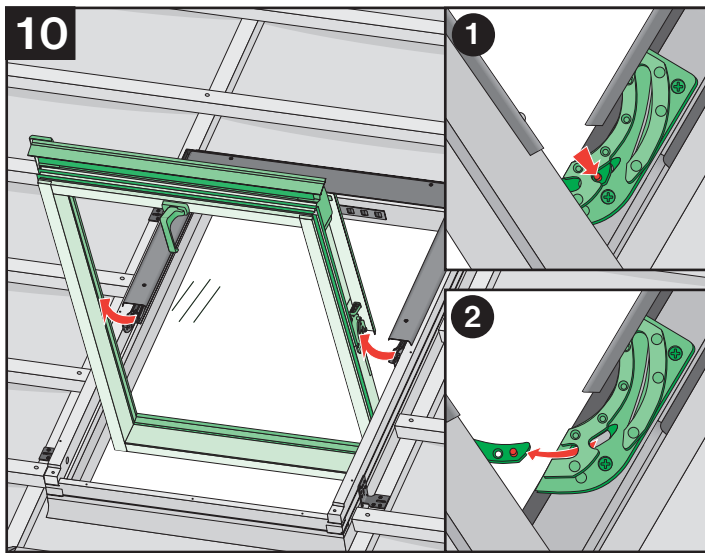
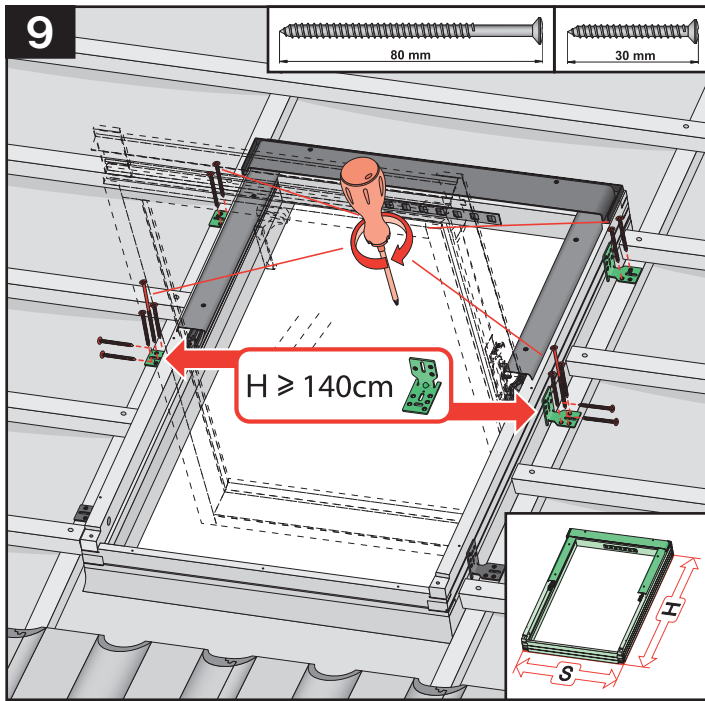

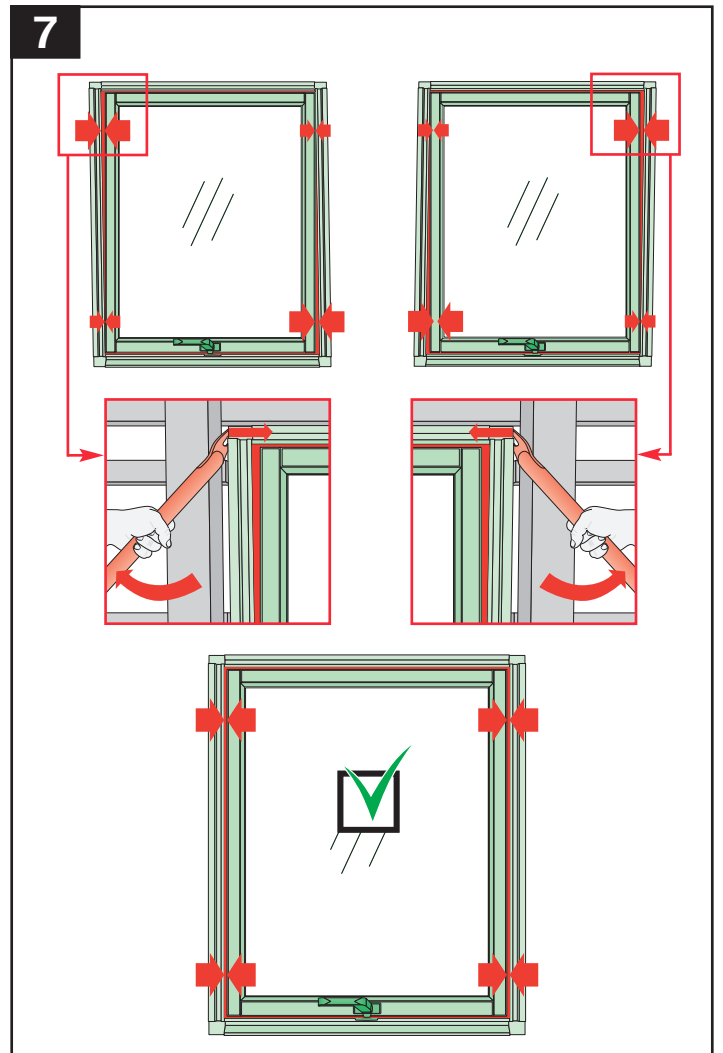
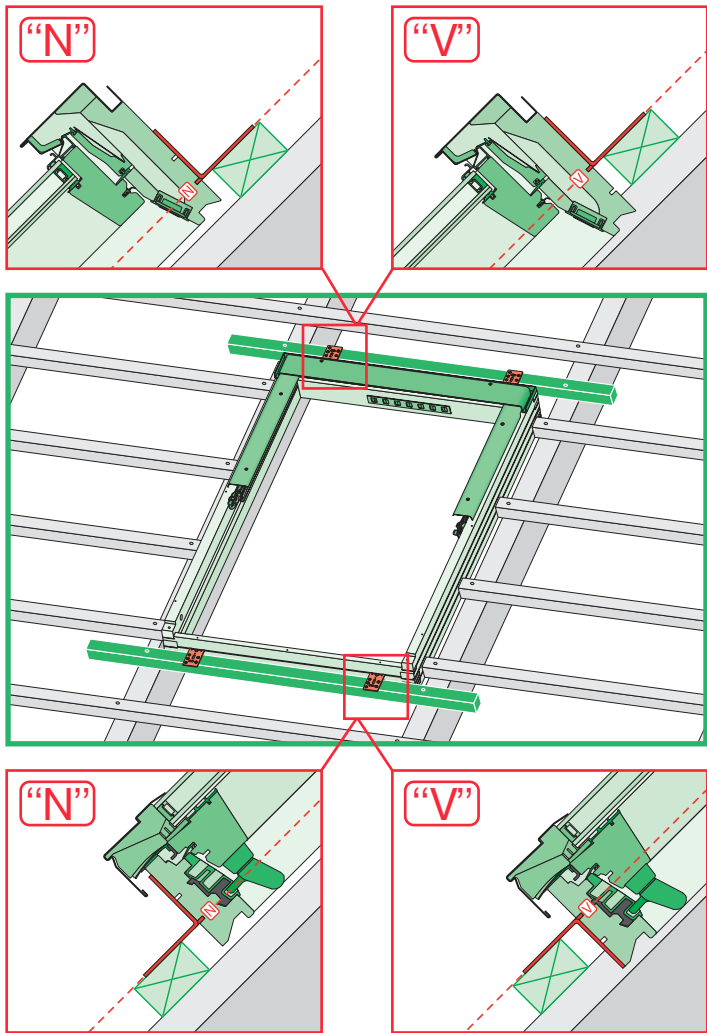

	max 90mm	EHN		
		EHV		
	-	-	-	-
	max 45mm	EZN		
		EZV		
	-	-	-	-
	max 15mm (N) max 5mm (V)	ELN		
		ELV		
	-	-	-	-
	max 5mm	ESN		
		ESV		
	-	-	-	-

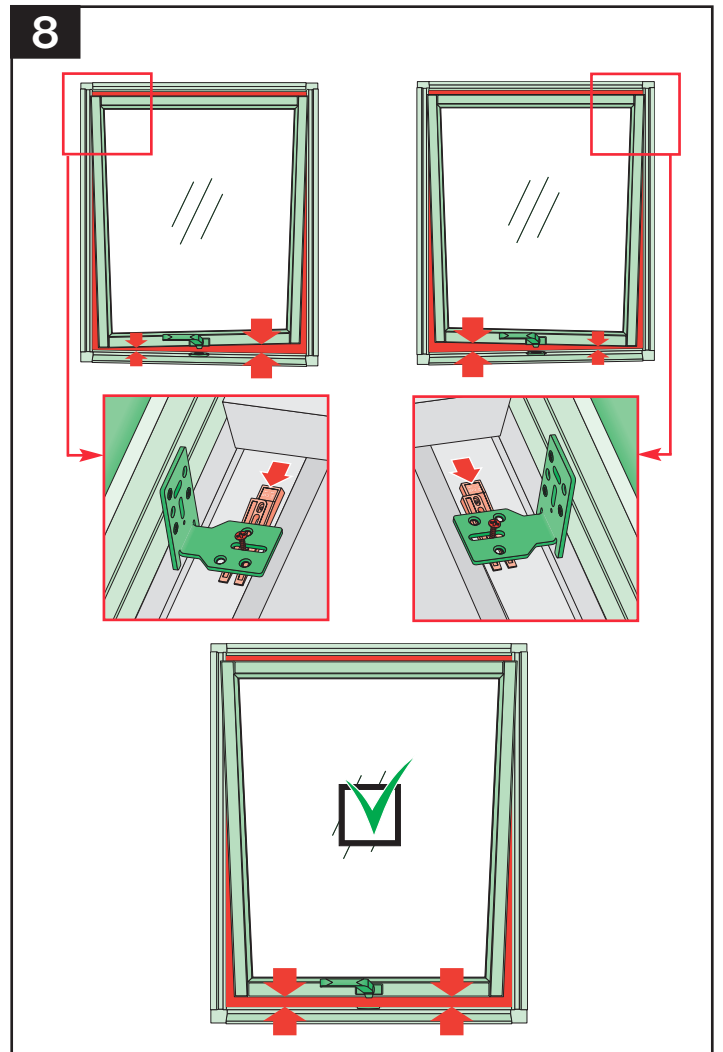

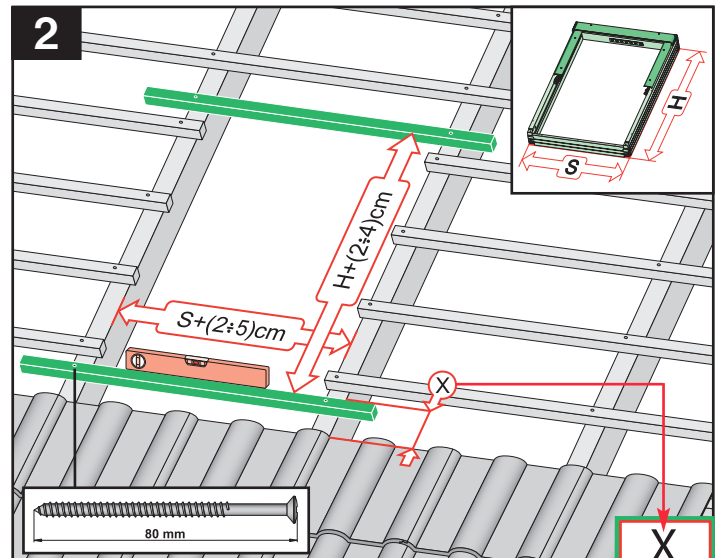
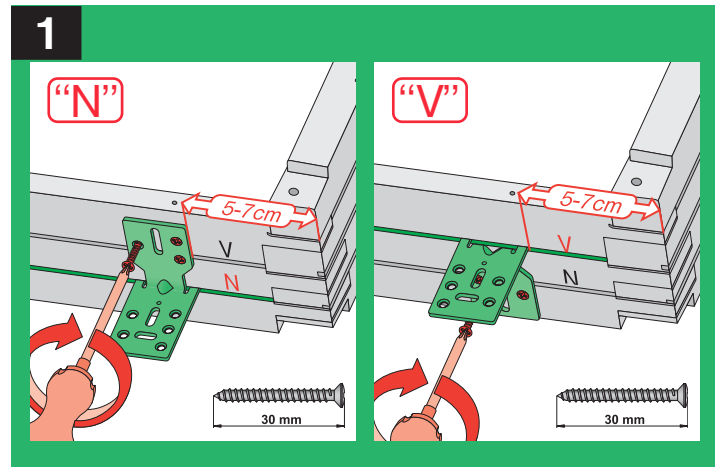
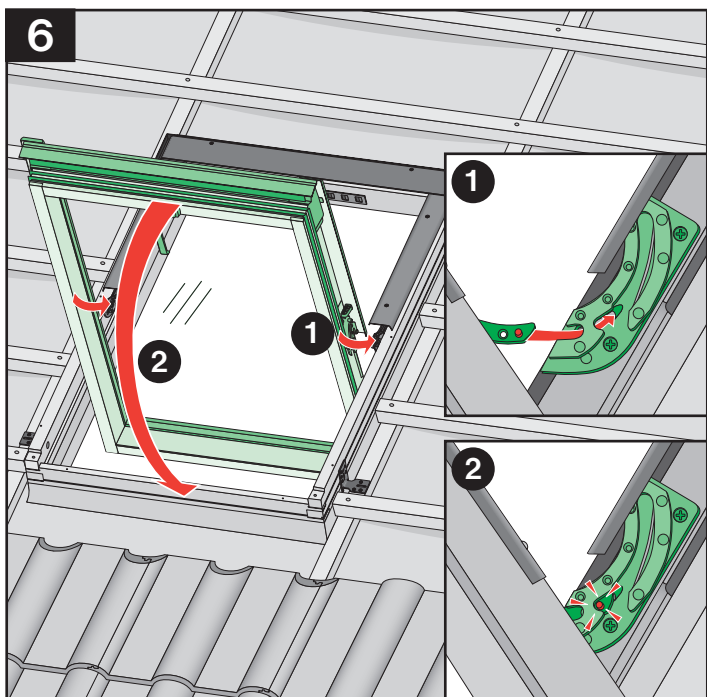
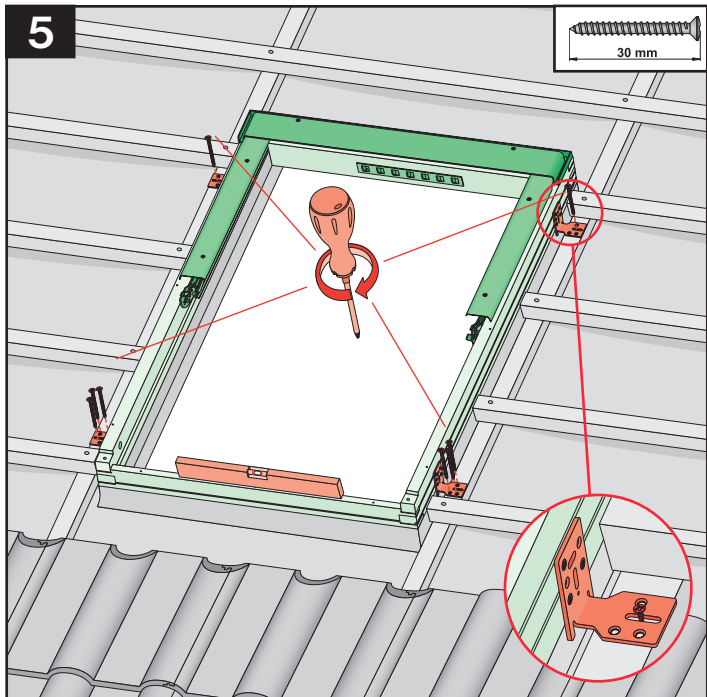
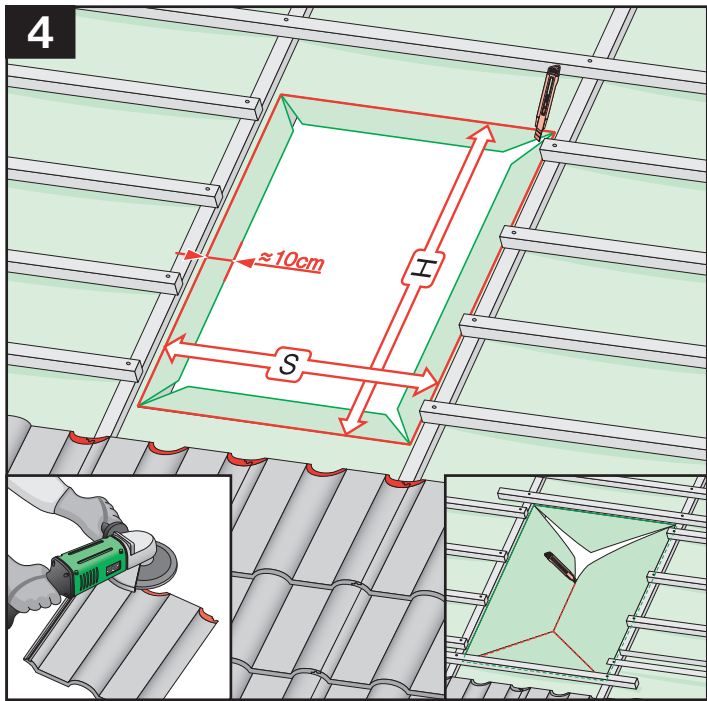

		X	
	EHN	7-10cm	7-10cm
	EHV	7-10cm	7-10cm
	EZN	6-8cm	6-8cm
	EZV	6-8cm	6-8cm
	EGV	4cm	4cm
	EPV	6cm	6cm
	ELN	0-2cm	0-2cm
	ELV	0-2cm	0-2cm
	EEN	0-2cm	0-2cm
	EEV	0-2cm	0-2cm

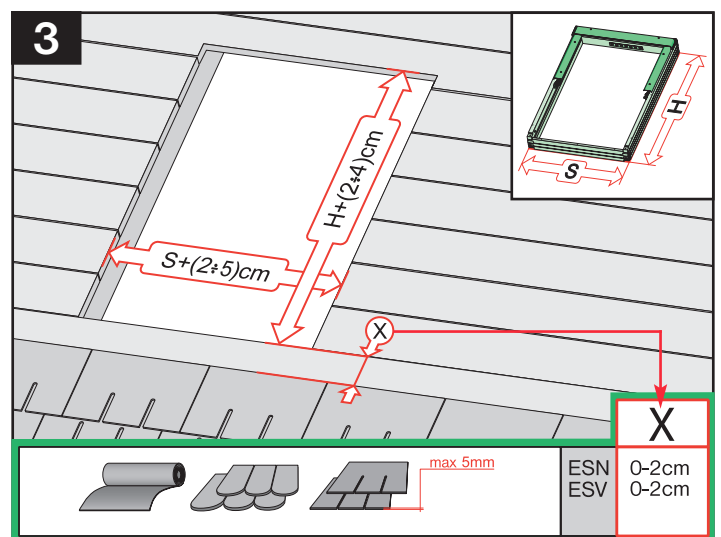

		X	
	ESN	0-2cm	0-2cm
	ESV	0-2cm	0-2cm

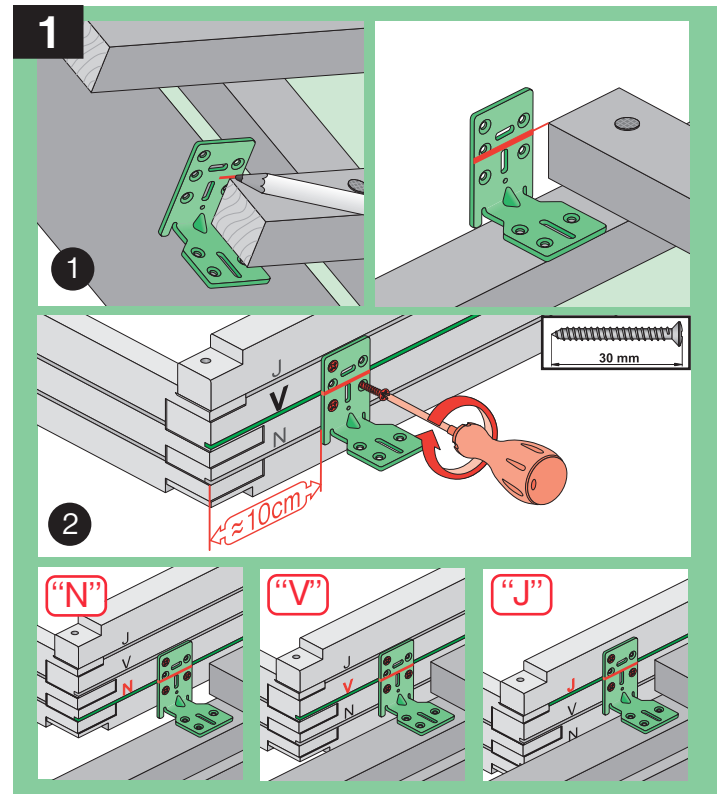
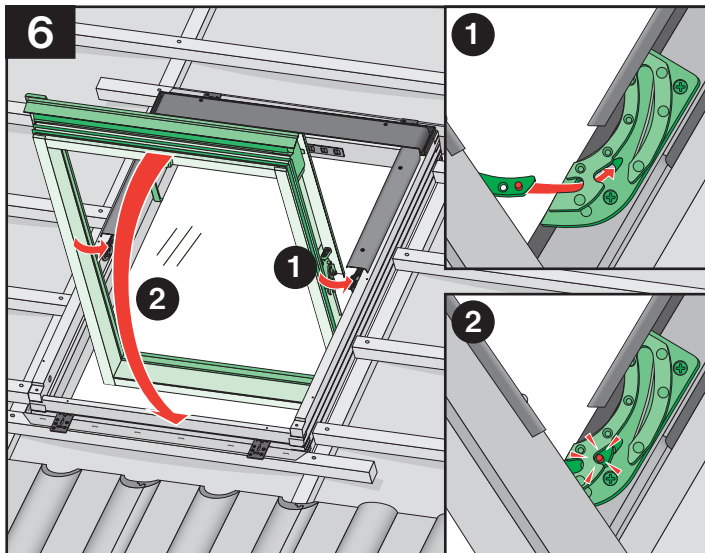
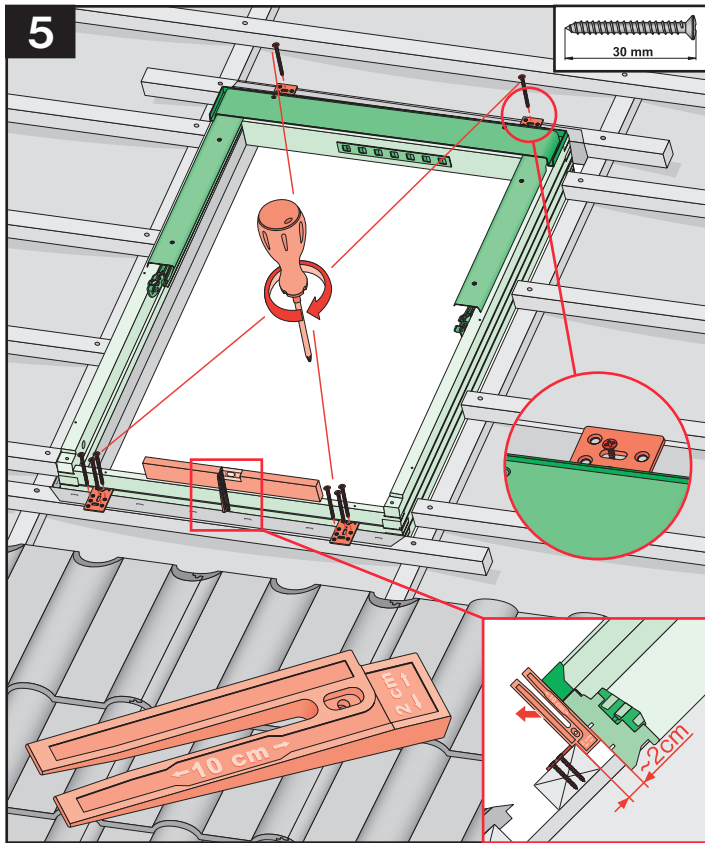
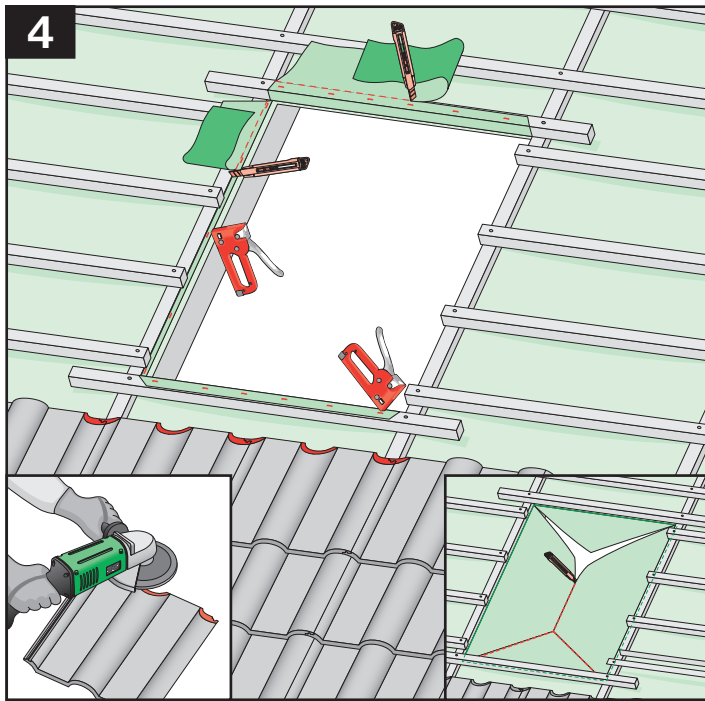

	max 90mm	EHN	9-12cm
	max 45mm	EZN	8-10cm
	8-10cm	EZV	8-10cm
	20cm	EZJ	20cm
	12-16mm	EGV	6cm
	max 18mm	EPV	8cm
	max 5mm (V,J) max 15mm (N)	ELN	0-4cm
		ELV	0-4cm
		ELJ	11cm
		EEN	0-4cm
		EEV	0-4cm
		EEJ	11cm

	max 5mm	ESN	0-4cm
		ESV	0-4cm
		ESJ	11cm

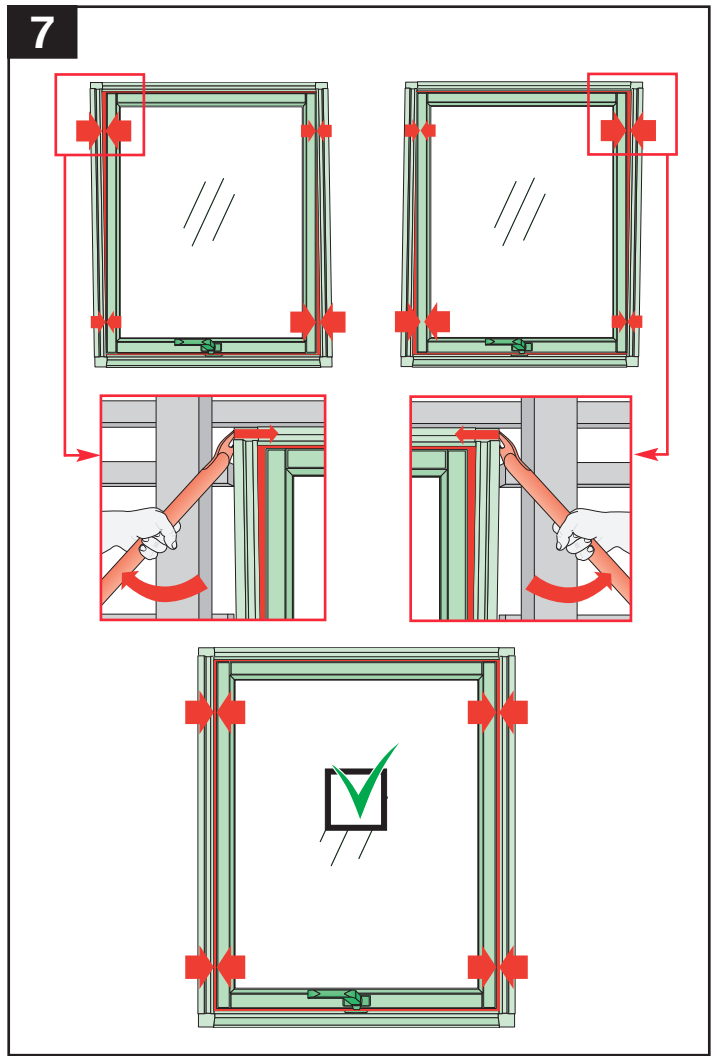
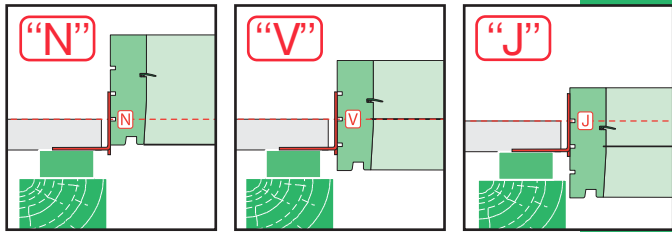
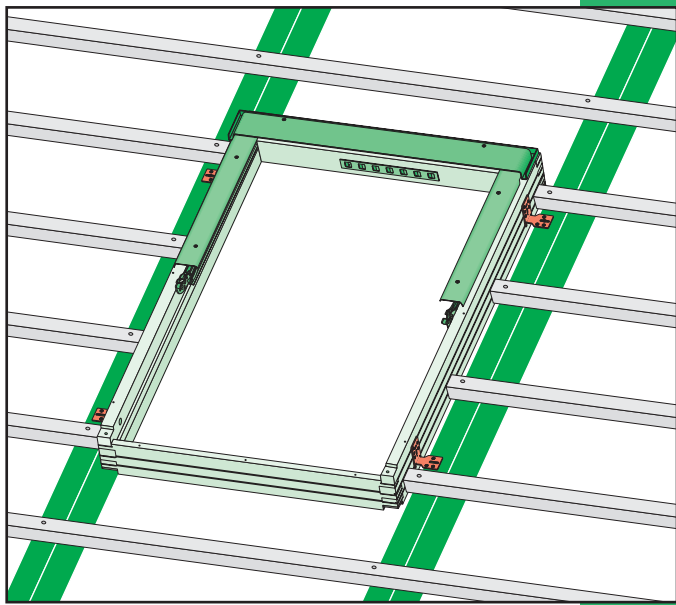

	max 90mm	EHN		
		EHV		
		-	-	-
	max 45mm	EZN		
		EZV		
		EZJ		
	max 15mm (N) max 5mm (V) max 5mm (J)	ELN		
		ELV		
		ELJ		
	max 5mm	ESN		
		ESV		
		ESJ		

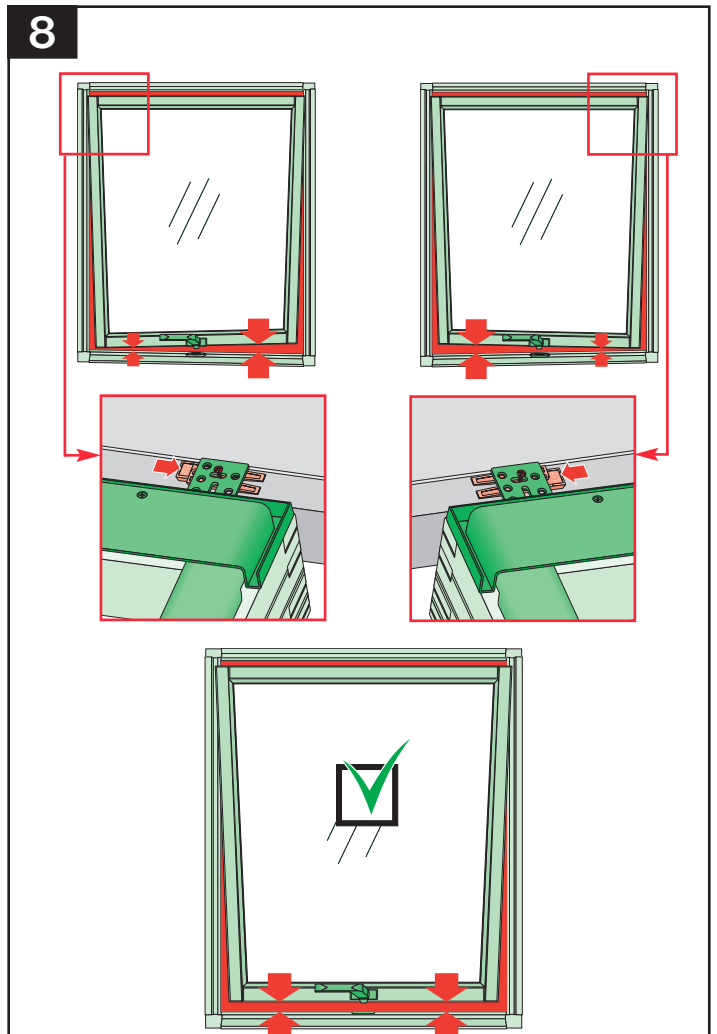

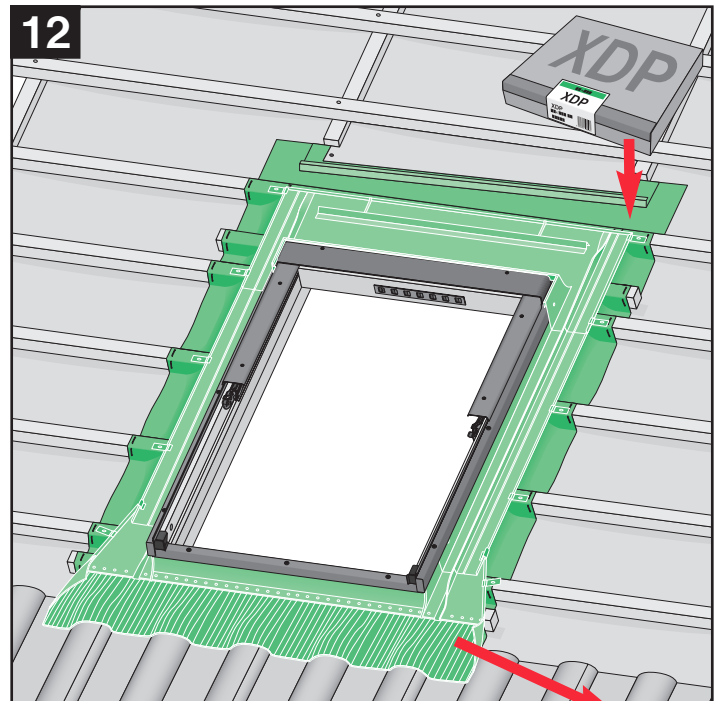
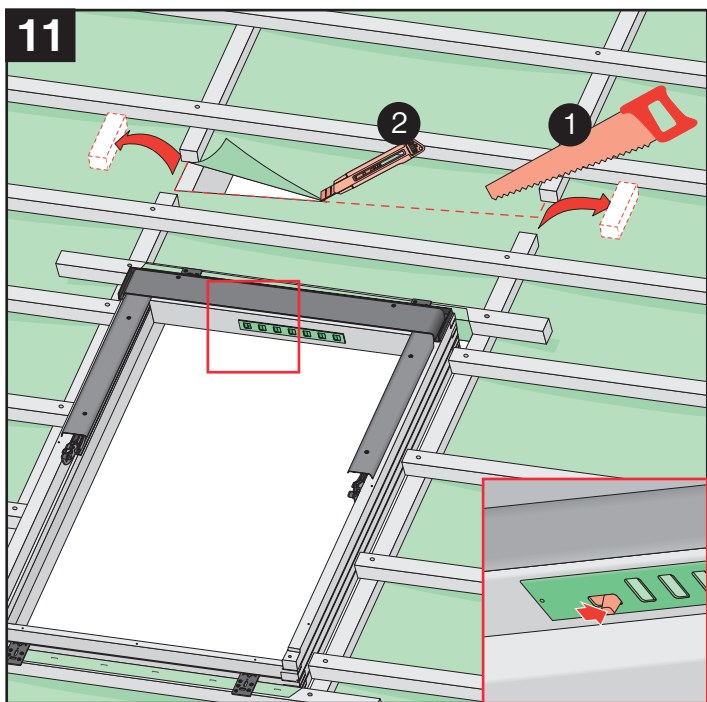
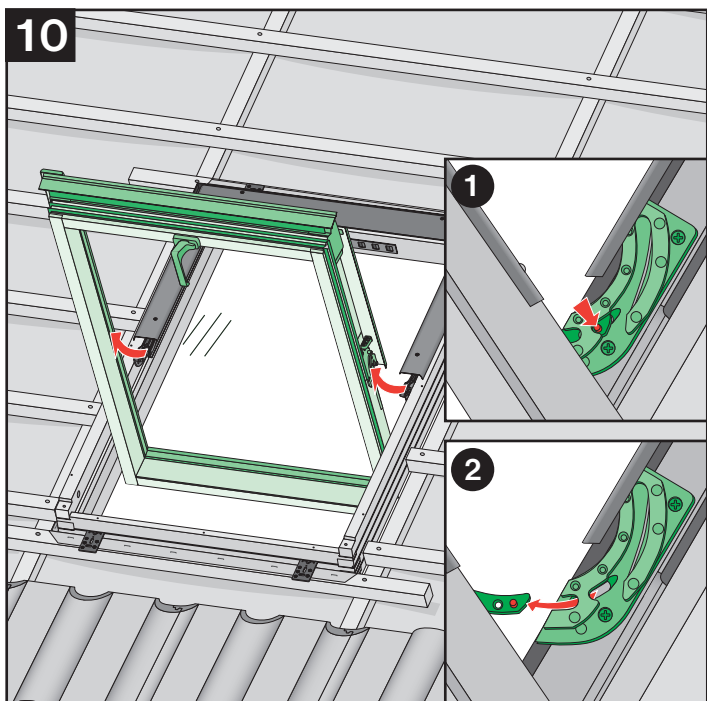
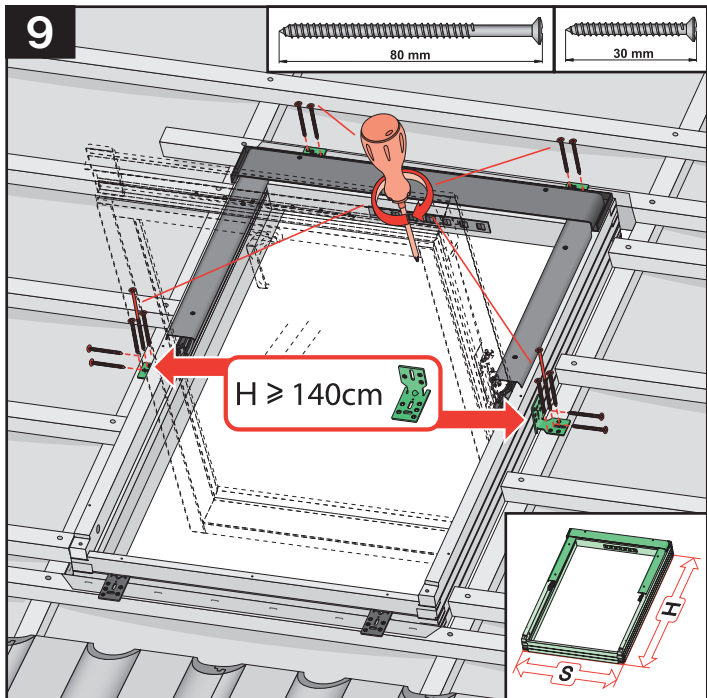

	max 90mm	EHN EHV
	max 45mm	EZN EZV
	max 5mm	ESN ESV
	12-16mm 350-420mm	EGV
	max 18mm 250-280mm	EPV
	max 5mm (V) max 15mm (N)	ELN ELV
		EEN EEV